

Assembly instructions

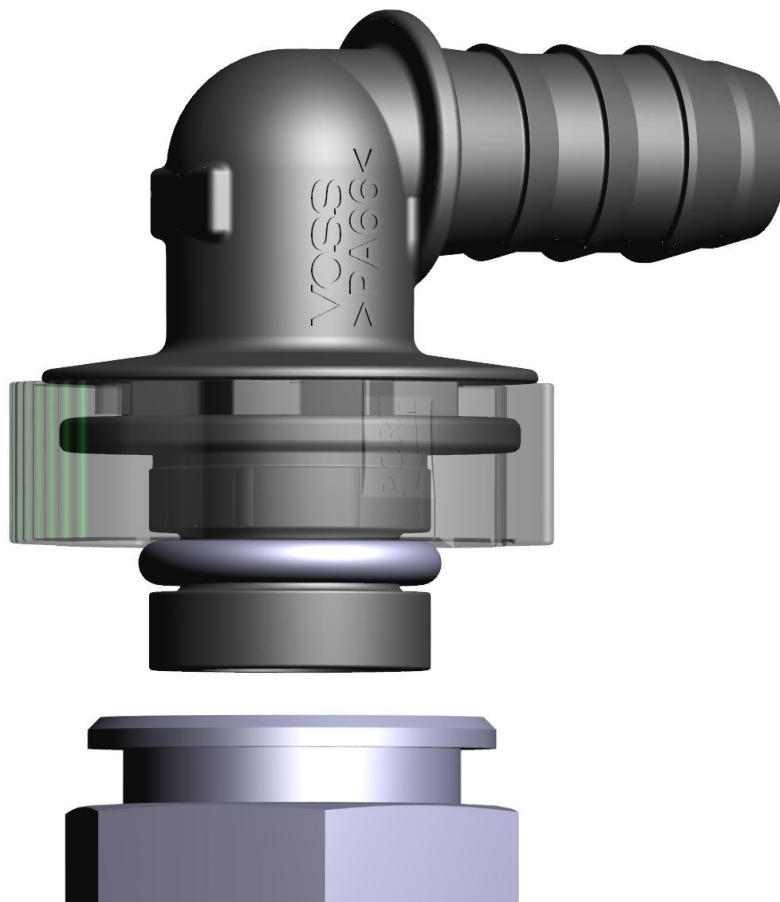



VOSS quick connect system 246 NX









Convenient connection, positioning
and release

A. Important notices





Please observe before using the quick connect system

-  VOSS quick connect system 246 NX is suitable for the following fluids: diesel, biodiesel, coolant, and AdBlue[®]/DEF. Different applications may require different O-ring materials.
-  Temperature range from -40 °C to +120 °C, temporary +140 °C
-  Maximum operating pressure 10 bar, depending on applied tube materials and dimensions
-  When using the quick connect system in other applications, suggestions available upon request.

Please observe during the assembly of the quick connect system

-  The assembly of the quick connect system must be conducted by professional mechanics subject to these assembly instructions.
-  Incorrectly assembled connections can result in fluid leakage and failure of the system.
-  VOSS quick connect system 246 NX may only be used with ports and tubes made of materials described in chapter B (components and materials).
-  Do not connect nylon tube and fir-tree with hose clips or clamping sleeves.
-  The O-ring must be greased.
-  Do not remove the connecting cap until ready for assembly.

General information

-  VOSS quick connect system 246 NX permits rapid and safe connections of nylon tubes to system components and between lines.
-  VOSS quick connect system 246 NX features a particularly space-saving construction, making it useful in tight installation spaces.
-  The retaining element can be rotated. It can be aligned in 8 steps and thus be adapted to the specific installation space situation for a comfortable disassembly.
-  Different fir-tree and respective tube dimensions can be distinguished by color markings on the retaining element.
-  VOSS quick connect system 246 NX is also available as an electrically heated variant. Please ask for a special assembly instruction if needed.

B. Components and materials

1. Plug

Straight and elbow plugs are available in two different nominal sizes (NS): NS 8 and NS 12. Fir-tree sizes (designated as “nominal width”, NW) differ in respect to the inner diameter of the tube. Different nominal widths can be distinguished by color markings on the retaining element. The plug is made of polyamide and will be supplied with a protective cap. The system is available with different O-ring materials depending on the fluid.



Fig. 1: Elbow plug NS 8, NW 6 with protective cap

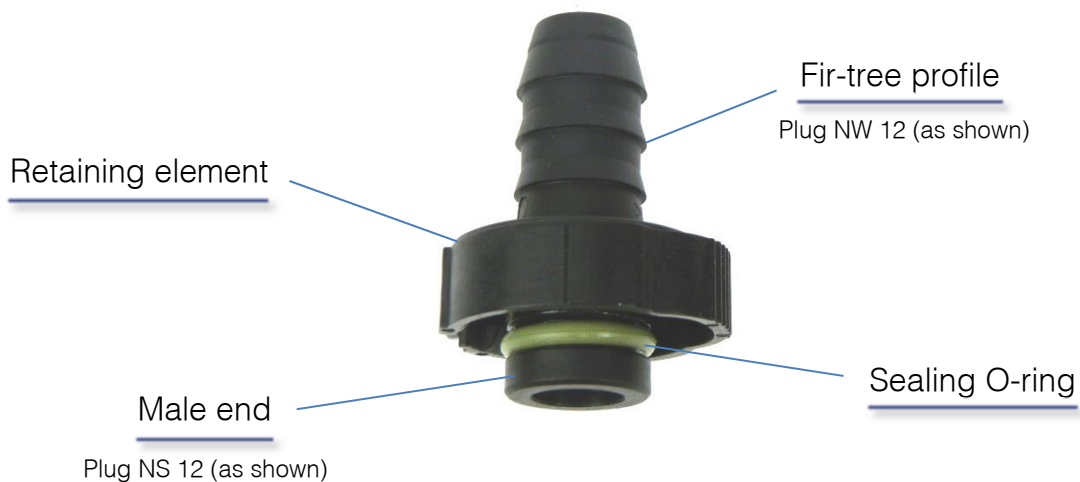

Fig. 2: Components of the plug, without protective cap

O-ring materials	
Application	O-ring material
Diesel fuel acc. to DIN EN 590	NBR, FPM
Biodiesel acc. to DIN EN 14214	FPM
Coolant	EPDM
AdBlue®/DEF	EPDM

Tab. 1: O-ring materials

2. Connecting port

Plugs can be connected directly to system components if they are equipped with the special connecting port for VOSS quick connect system 246. For other types of connections VOSS offers a wide range of adapters, inline connectors and manifolds. The connecting port is made of nylon or metal.

If necessary, VOSS will provide detailed specifications of the connecting port. The connecting port for quick connect system 246 NX and ports for previous 246 system variants (e.g. 246 Standard, 246 AX) are identical.



Fig. 3: System component with nylon ports

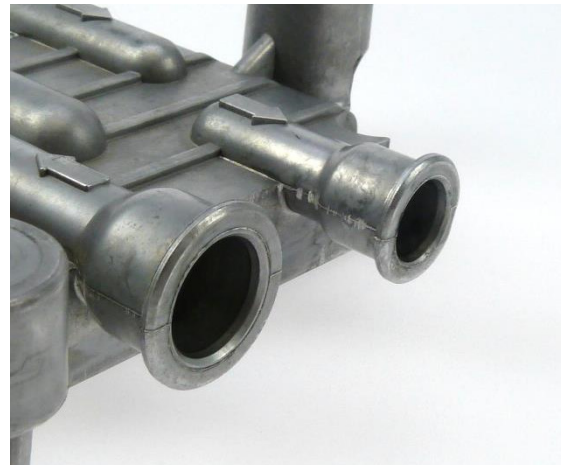

Fig. 4: System component with aluminum ports



Fig. 5: Adapters



Fig. 6: Inline connectors



Fig. 7: T-manifold



The optimized low version of the connecting port can be used only for the system variants 246 Standard and 246 NX.

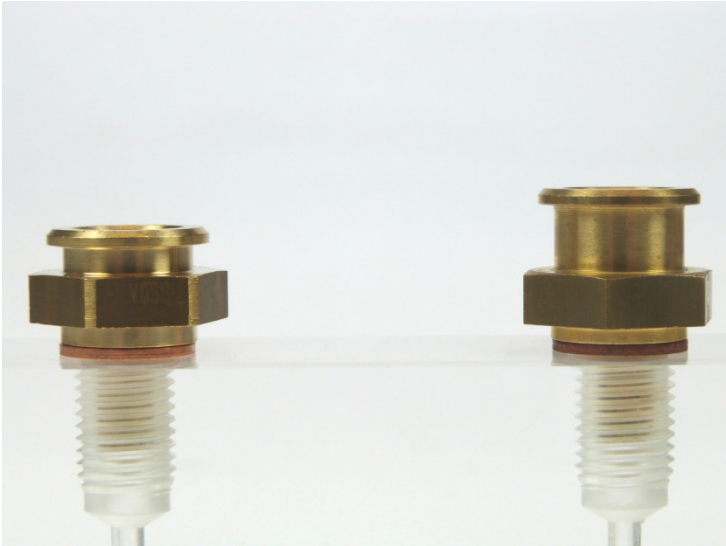

Fig. 8: Adapter NS 8 with low (left) and higher (right) connecting port

3. Lines

Depending on the application, nylon tubes may be applied to the fir-tree of quick connect system 246 NX.

Diesel and biodiesel:
Polyamide tubes according to DIN 73 378 and DIN 74324

Materials:

PA 11 – PHL

PA 12 – PHL

PA 11 – PHL Y

PA 12 – PHL Y



Other materials on request.

Monolayer and multilayer coolant tubes

Polyamide tubes for AdBlue®/DEF



4. Assembly instructions

Use of arrow symbols in pictures:

-  Indicates special points of interest described in the text.
-  Indicates required manual actions and their direction.
-  Indicates operations that should be avoided.

4.1. Assembly of the nylon tube

4.1.1. Cutting the nylon tube to length

-  The nylon tube must be cut at a right angle.
-  The nylon tube must not be cut using a saw, as this causes burring. Burring reduces the sealing ability of the connection.

When cutting the nylon tubes to length, we recommend the use of the VOSS cutting pliers (see fig. 9). Using the VOSS cutting pliers will ensure the tube is cut cleanly and at a right angle. Subsequent treatment of the cut surface, such as deburring, is then no longer necessary.



Fig. 9: VOSS cutting pliers for nylon tubes

4.1.2. Insertion of the fir-tree into the nylon tube

When pressing the fir-tree into the nylon tube:

- ! The insertion procedure must be performed at room temperature.
- ! The nylon tube must not be heated.
- ! The nylon tube must be undamaged.
- ! The fir-tree profile must be clean and free of any grease.
- ! The fir-tree profile must be undamaged, otherwise the connection to the nylon tube will not be tight.

Insertion with the manual assembly tool

The manual assembly tool (fig. 10) is available from VOSS.

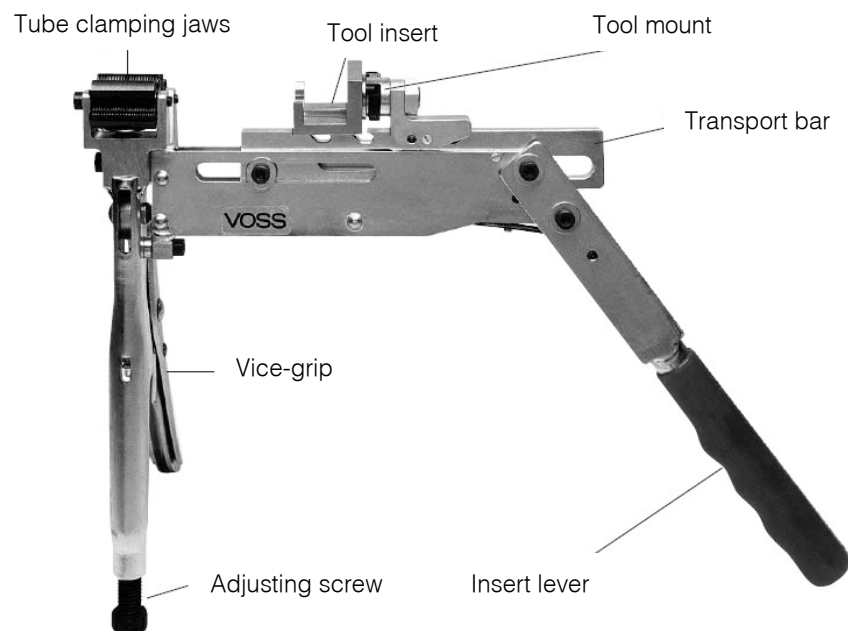

Fig. 10: VOSS manual assembly tool

Step 1

Attach the correct tool mount into the intended plug (straight or elbow).

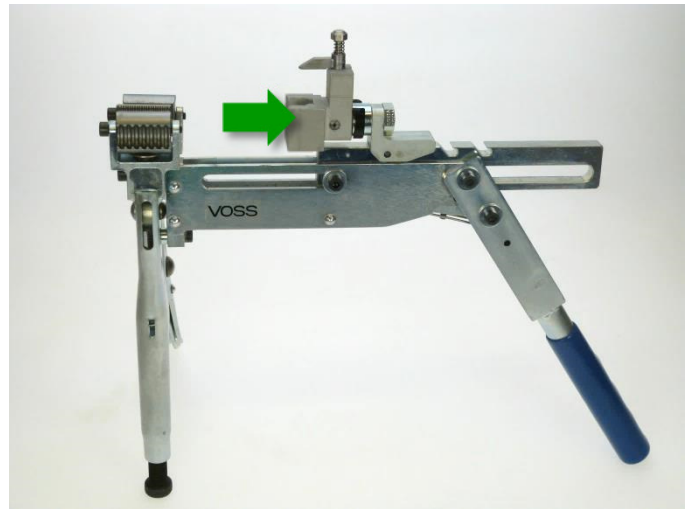

Fig. 11

Step 2

Place the intended plug with protective cap into the tool mount.

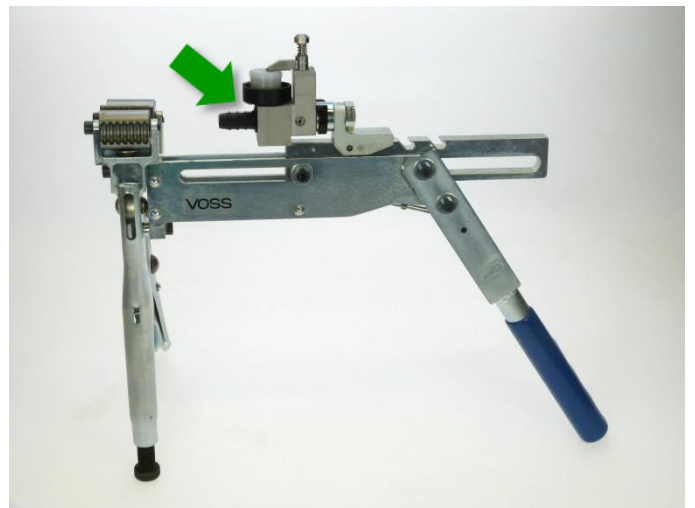

Fig. 12

Step 3

Clamp the jaws around the diameter of the tube.

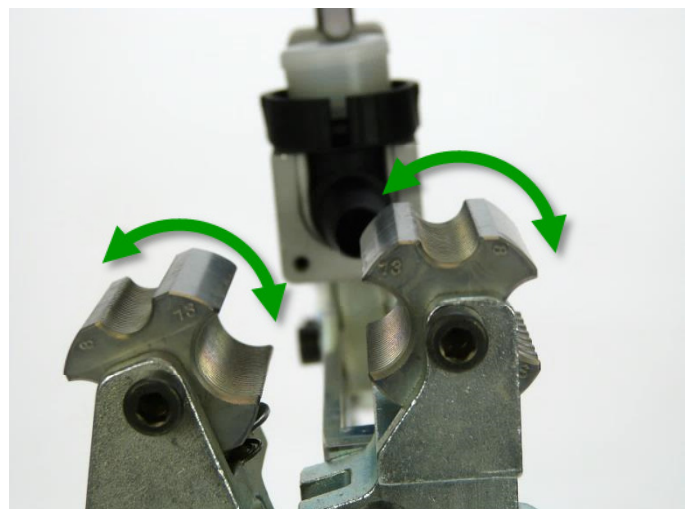

Fig. 13

Step 4

Insert the nylon tube into the clamping jaws. The overlap of the tube must be at least 2 mm longer than the length of the plug's fir-tree.

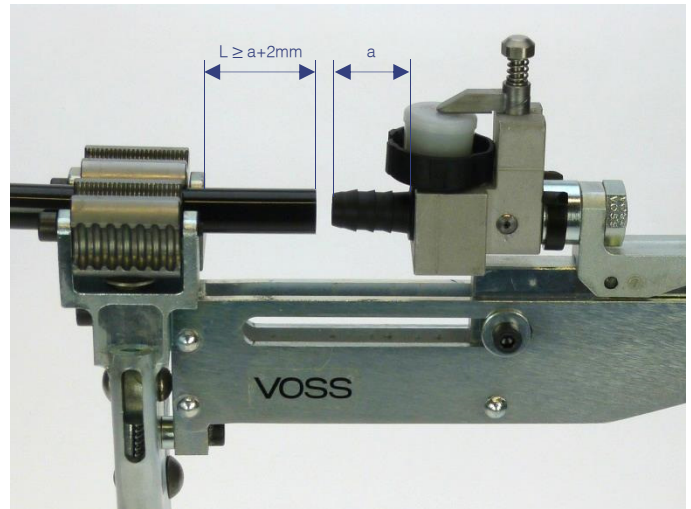

Fig. 14

Step 5

The vice-grip secures the nylon tube. The clamping force can be regulated with the adjusting screw.

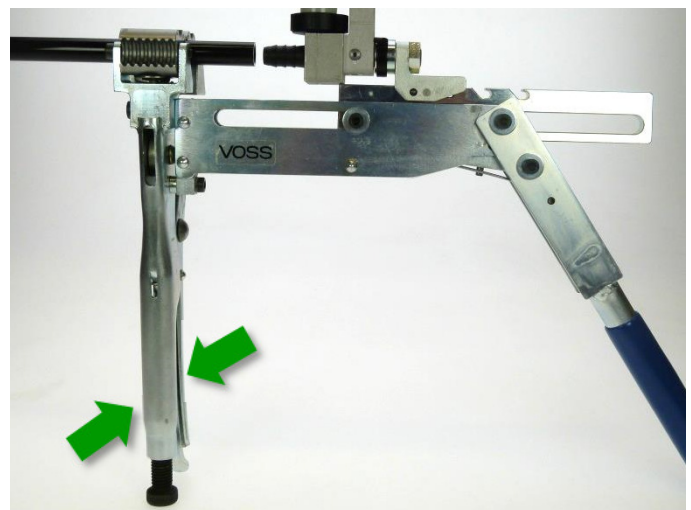

Fig. 15

Step 6

Move the transport bar, centering the fir-tree into the inner diameter of the nylon tube.

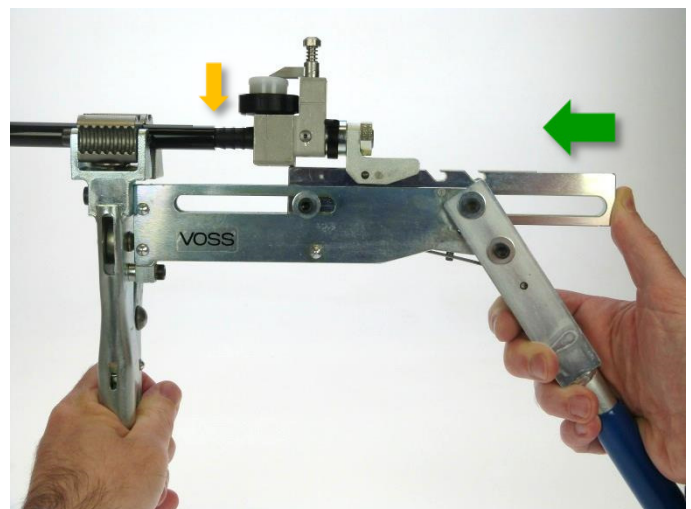

Fig. 16

Step 7

The fir-tree has to be inserted completely into the nylon tube with the insert lever, until the stop limit is reached. There should be no gap > 0.5 mm.

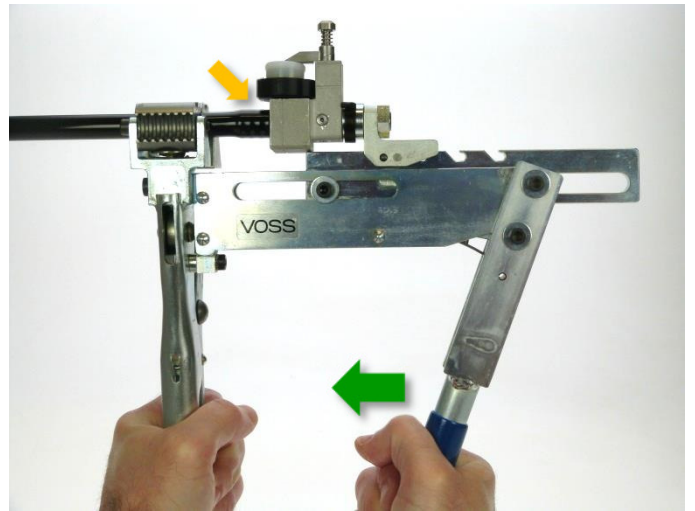

Fig. 17

Step 8

Move the insert lever back.

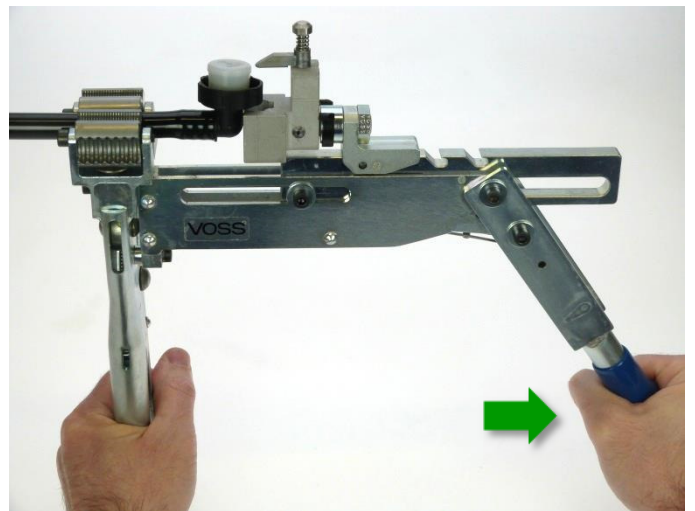

Fig. 18

Step 9

Move the transport bar back. The plug is then released.

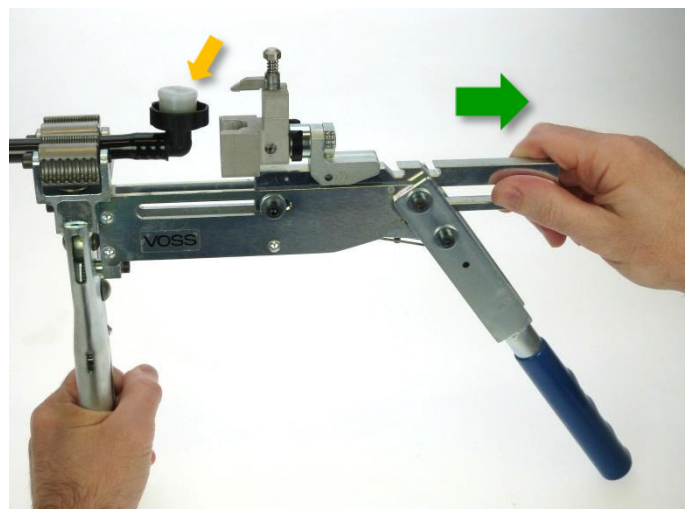

Fig. 19

Step 10

Release the vice-grip; remove the assembled line.

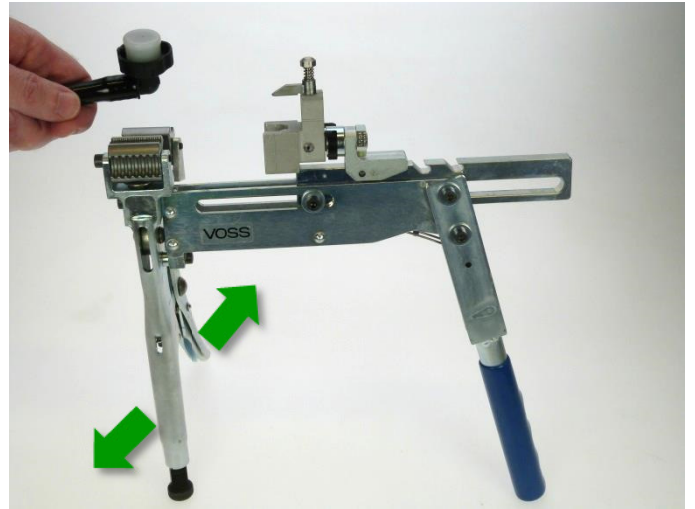

Fig. 20

Nylon tube correctly mounted on the fir-tree.

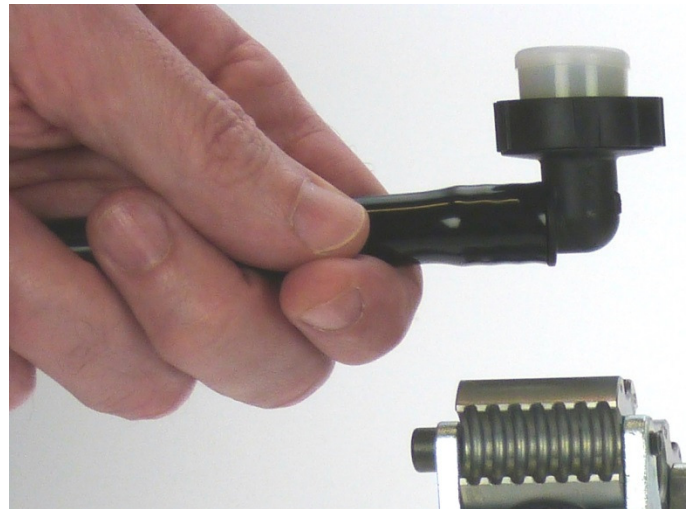

Fig. 21

Assembly machine for series assembly

VOSS offers the assembly machine type 56 for series assembly of nylon tubes on fir-trees.

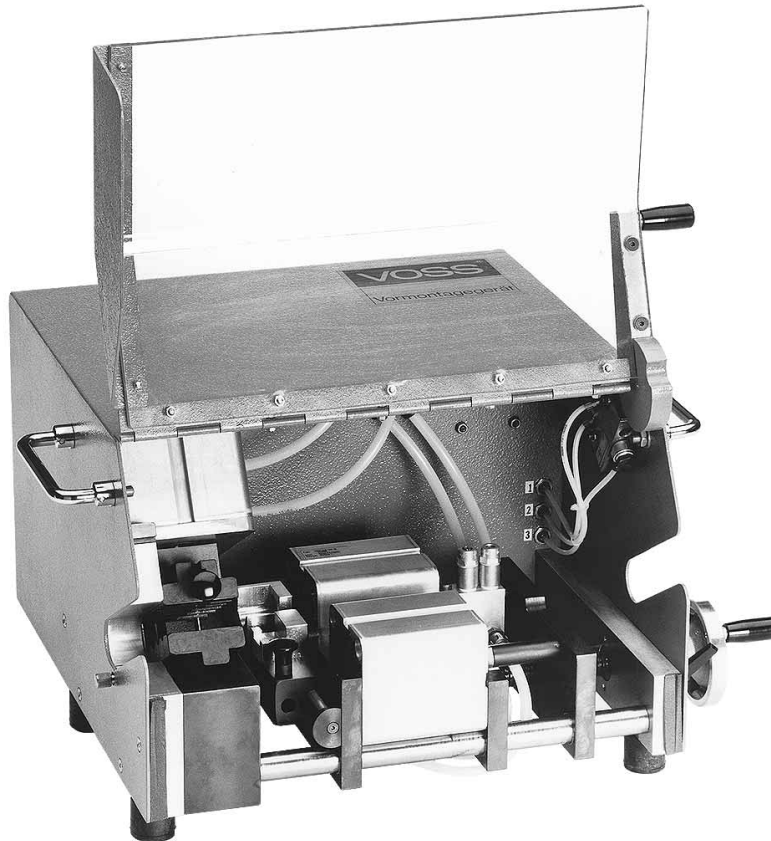

Fig. 22: VOSS assembly machine type 56

4.2. Inserting quick connectors into the connecting port

- ! Before inserting the plug, check the connecting port, especially the bore-hole.
- ! The connecting port must be clean and must not show any signs of damage.
- ! The O-ring must be greased.

Initial situation

The plug with the tube mounted correctly on the fir-tree above a connecting port



Fig. 23

Step 1

The VOSS quick connect system 246 NX plug must be inserted into the bore-hole until the retaining element locks below the collar of the connecting port.

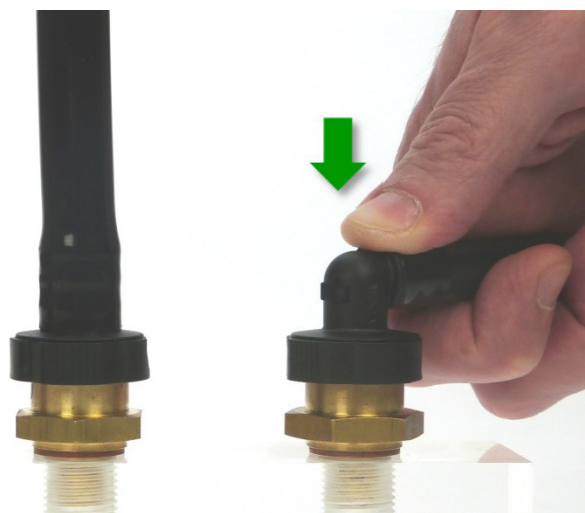

Fig. 24

Step 2

Check for correct locking by pulling the line in the opposite direction.

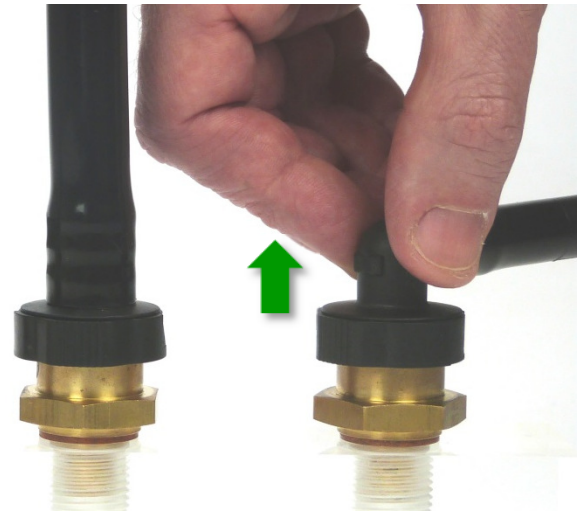

Fig. 25

Step 3

To make disassembly easier in the future, rotate the retaining element to the most convenient position. It can be set in 8 different positions.

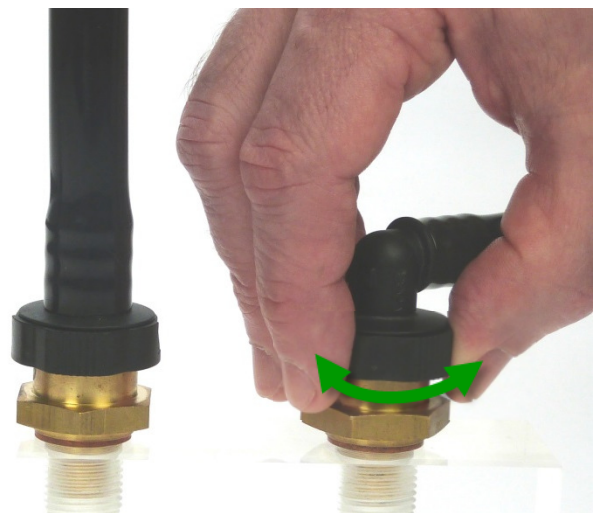



Fig. 26

4.3. Disassembly

 Before disconnecting, the line must be free of pressure.

Step 1

To make disassembly easier, the retaining element can rotate and be set into 8 different positions.

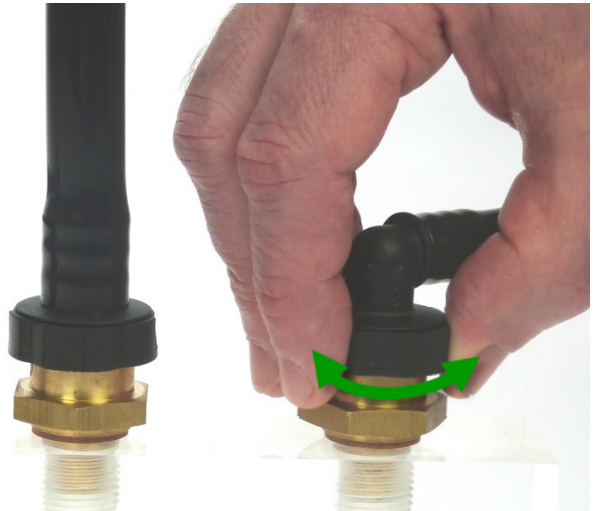

Fig. 27

Step 2

Press the corrugated segment of the retaining element to open.



Fig. 28

Step 2, example no. 1

Observe the corrugated segment below the tube.
Release with index finger.

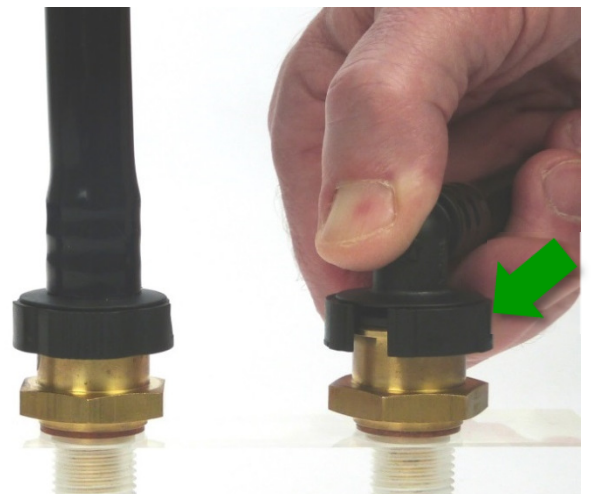

Fig. 29

Step 2, example no. 2 (not convenient)

Observe the corrugated segment on the side.
Release with the thumb.
The hand impedes the circular release element.

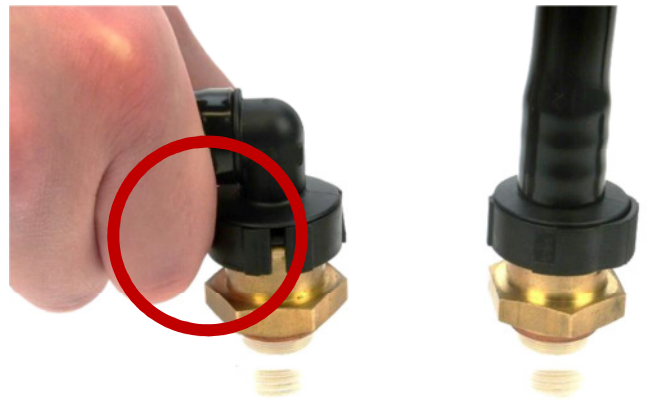

Fig. 30

Step 2, example no. 2 (recommended)

Observe the corrugated segment on the side.
Release with the thumb.
The hand does not impede the circular release element.

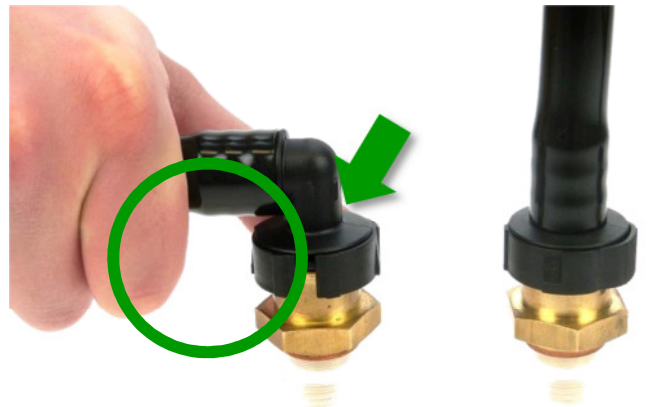

Fig. 31

Step 3

While keeping the pressure on the release element, the plug
can be pulled out of the connecting port.



5. Design and routing of lines

- ! Lines must be sufficiently flexible to guarantee the required minimum free space (fig. 32) for VOSS quick connect system 246 NX above the connecting port.

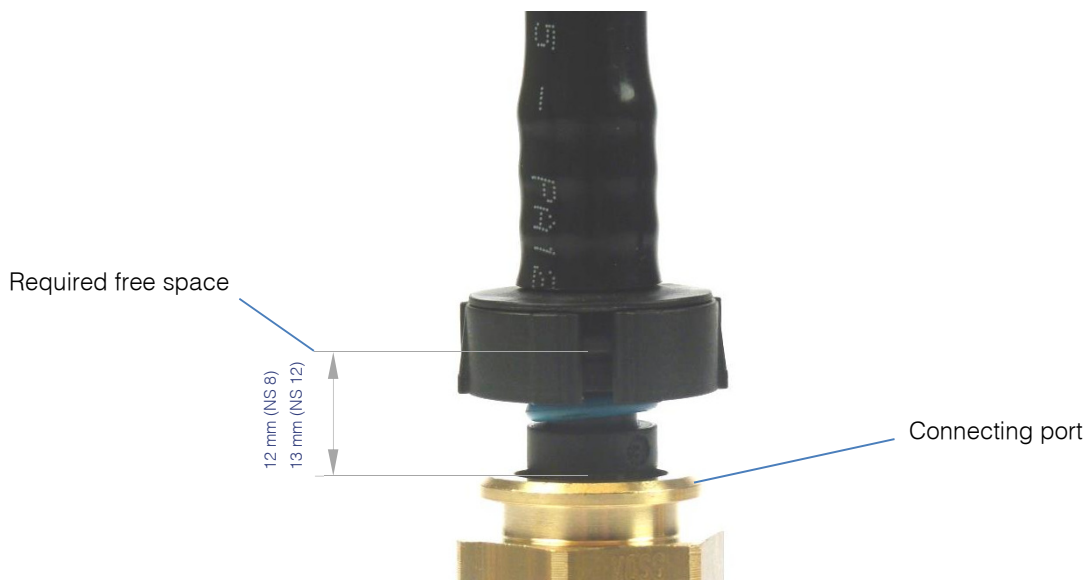

Fig. 32: Required free space for inserting VOSS quick connect system 246 NX

- ! Lines have to be routed in a manner that they are free from stress or torsion. To prevent any damage arising from vibrations, pressure surges or bending loads, the lines must be kept stable with suitable brackets.
- ! Depending on the type of material combination with the connecting port, torsional vibration (see fig. 33) can result in failure of the connection. Such load conditions must be avoided.



Fig. 33: Torsional vibration

Customer service

Contact VOSS for questions concerning quick connectors, nylon tubes, laying of lines, etc.

Property rights

All rights reserved in regard to patents, registered designs, and trademarks. Drawings of the VOSS quick connect system 246 NX may not be reproduced or made accessible to third parties without our prior consent.

Technical modifications and errors excepted.

Contact

VOSS Automotive GmbH
P. O. Box 15 40
51679 Wipperfürth
Leiersmühle 2-6
51688 Wipperfürth
Germany
Phone: +49 2267 63-0
Telefax: +49 2267 63-5982
automotive@voss.net
www.voss.net